

# GAGE BILT...solutions

## Introducing the GB731BBLB-08

GAGE BILT now offers a complete tool kit for installing CHERRYMAX® 1/8" – 3/16", HUCK® and CHERRY® blind bolts thru 1/4" per MS21140 & MS21141 (U or S) and MS90353 & MS90354 (U or S) and 5/32" thru 1/4" NAS Tension and NAS Shear lockbolts.

The basic kit, GB731BBLB-08 contains: a pintail catcher bag and a grip selection gage and Nose Assemblies:

- CHERRYMAX- Straight and Right Angle with stroke limiter.
- Blind Bolts- Straight noses to install -5, -6 and -8 diameters.
- Lock Bolt- Straight noses to install -6 and -8 diameters.



All these items are stored in an easy access carrying case with manuals and data sheets.



**GAGE BILT**  
MADE IN U.S.A.





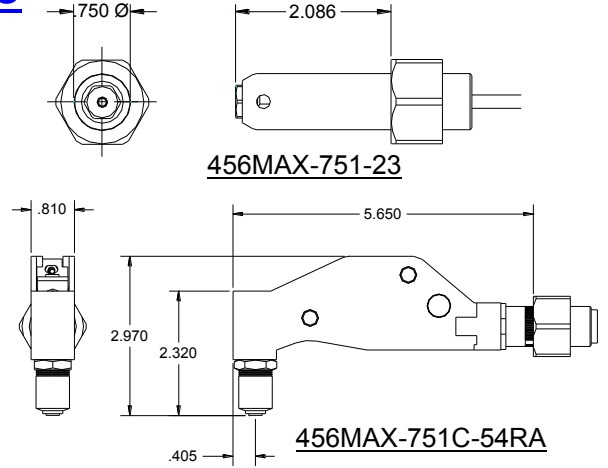

**GAGE BILT Inc.**  
44766 Centre Court (586) 226-1500  
Clinton Twp. MI 48038 (586) 226-1505 Fax  
e-mail: [solutions@gagebilt.com](mailto:solutions@gagebilt.com) / [www.gagebilt.com](http://www.gagebilt.com)

# GB731BBLB-08

CHERRYMAX®, ALLMAX®, HUCKMAX® NAS9301-9312, M7885 BACR15FP/FR & BACR15GF/GK	DIA.	NOSE ASSEMBLIES	
		STRAIGHT	RIGHT ANGLE
	1/8"	456MAX-751-23 (PULLS ALL 3)	*456MAX-751C-54RA (PULLS ALL 3)
	5/32"		
	3/16"		

\*Right Angle nose assemblies require 731154 stroke limiter.





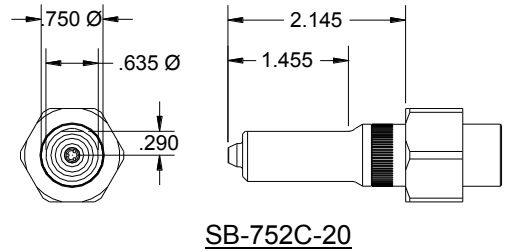



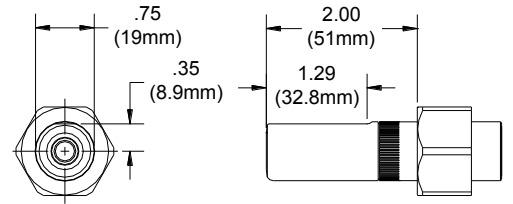

BLIND BOLT MS90353S & U / MS90354S & U MS21140S & U / MS21141S & U CR7000 SERIES BACB30YY, YU, & YT	DIA.	NOSE ASSEMBLIES	
		STRAIGHT	
	5/32"	SB05-752C-20	
	5/32"		
	3/16"	SB06-752B-20	
	3/16"		
	1/4"	SB08-713-20 (NOT FOR ALLOY STEEL)	
	1/4"		



**SB-752C-20**



**NAS08-731-20**

	3/16"	GPL3SC-V06, GPL3SP-V06, GPL3SC-DT06, GPL3SP-DT06, GPL3SC-EJ06, GPL3SP-EJ06, GPL8TC-V06, GPL8TP-V06, GPL8TC-DT06, GPL8TP-DT06, GPL8TC-EJ06, GPL8TP-EJ06	<b>STRAIGHT</b> NAS06-731-20
	3/16"	NAS1436, NAS1446, NAS2406, NAS2506, NAS7006, NAS7016, NAS7026, NAS7036	
	3/16"	NAS1456, NAS1466, NAS1476, NAS1516, NAS1526, NAS5136, NAS6936, NAS6946, NAS6956, NAS6966	
	3/16"	NAS2006, NAS2106, NAS2116, NAS2126	
	1/4"	GPL3SC-V08, GPL3SP-V08, GPL3SC-EJ08, GPL3SP-EJ08, GPL8TC-V08, GPL8TP-V08, GPL8TC-EJ08, GPL8TP-EJ08	<b>STRAIGHT</b> NAS08-731-20
	1/4"	NAS1438, NAS1448, NAS2408, NAS2508, NAS7008, NAS7018, NAS7028, NAS7038	
	1/4"	NAS1458, NAS1468, NAS1478, NAS1518, NAS1528, NAS6938, NAS6948, NAS6958, NAS6968	
	1/4"	NAS2008, NAS2108, NAS2118, NAS2128	

\*REQUIRES 751204 ADAPTER

